

Redefining portable

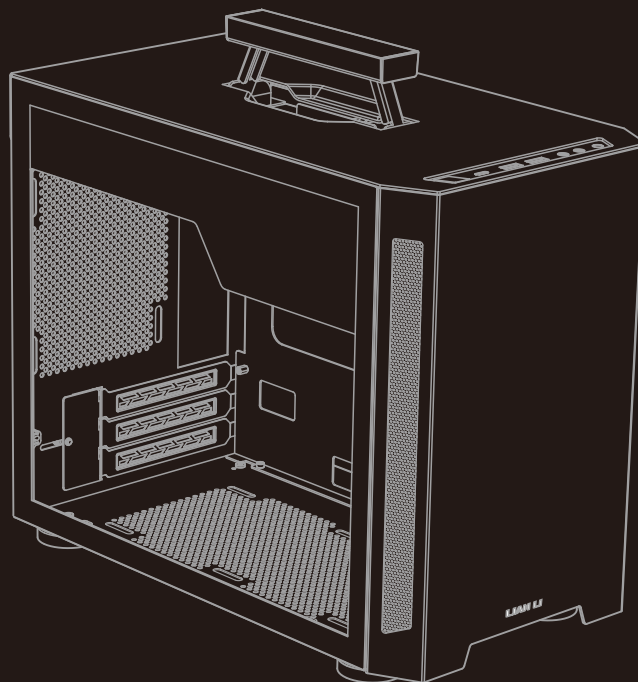

**LIAN LI**

Feel the difference

# TU150

Installation Guide / 安裝說明書  
Guide d'installation / Montageanleitung  
Guía de instalación / インストレーションガイド

\* Case components

\* 機殻部品紹介

\* Composants du boîtier

\* Gehäusekomponenten

\* Guía de instalación

\* ケース各部紹介

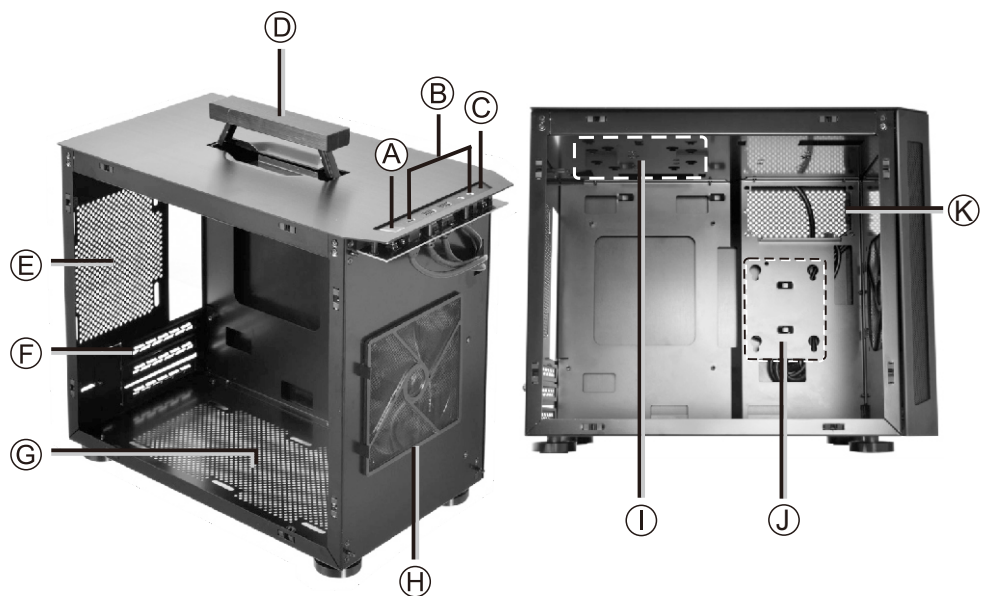

(A) Power switch

(B) IO ports: USB 3.1(Type-C) x 1, USB 3.0 x 2, HD audio

(C) Reset button

(D) Handlebar

(E) Support -120 mm fan or 120 mm AIO radiator

(F) PCI slots with ventilation

(G) Support -120 mm fans x 2

(H) Support -120 mm fan x 1, Removable air filter

(I) HDD rack (for 2.5"SSD x 1 or 3.5" HDD x 1)

(J) HDD rack (for 2.5"SSD x 1)

(K) PSU tray

\* Hardware list  
\* 零件盒部品一覧表

\* Liste des pièces  
\* Hardwareliste

\* Lista de materiales  
\* 付属品一覧

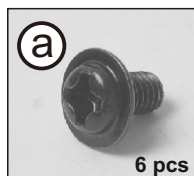

Screws for motherboard mount

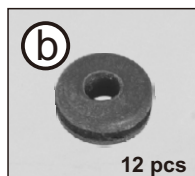

Anti-vibration rings for 2.5"SSD / 3.5" HDD mount



Screws for PSU mounting

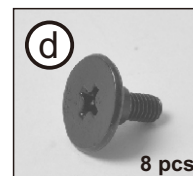

Screws for 2.5" SSD mount

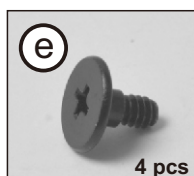

Screws for 3.5" HDD mount



Thumb screws for 2.5"SSD mount

※ Exceeded quantity are spare parts.  
※ 多餘的零件數量是備品。  
※ Les pièces supplémentaires sont des pièces de rechange.  
※ Zusätzliche Teile können als Ersatzteile verwendet werden.  
※ Exceeded quantity are spare parts.  
※ ネジには予備が含まれています。

\* I/O port installation  
\* USB 3.0 / 3.1 HD audio 接線定義  
\* Installation du port E/S  
\* I/O-Port installieren  
\* Instalación de los puertos de E/S  
\* I/O ポートに関して

USB 3.0 Supports motherboard USB 3.0 20 Pin header

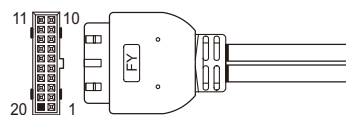

HD AUDIO

Blue	10	9	Green
Black purple	8	7	Key
Yellow	6	5	Orange
Gray	4	3	N.C.
Red	2	1	GND+H.S. TUBE



USB 3.1 GEN.2

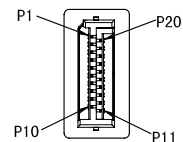

\* Cable installation guide  
\* 電源/系統指示燈接線定義  
\* Diagramme d'installation des câbles  
\* Kabel installieren  
\* Guía de instalación de los cables  
\* マザーボード接続ケーブルに関して

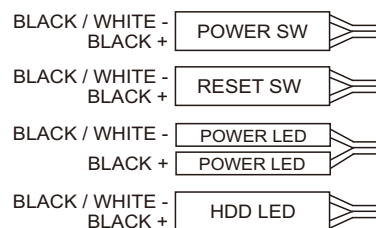

- \* Motherboard installation
- \* 主機板安裝
- \* Installation de la carte mère
- \* Motherboard installieren
- \* Instalación de la placa base
- \* マザーボードの取り付け

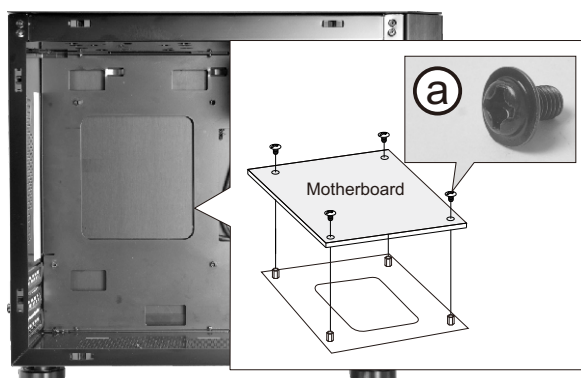

- \* PSU installation
- \* 電源供應器安裝
- \* Installation du plateau du bloc d'alimentation
- \* PSU-Einsatz installieren
- \* Instalación de la fuente de alimentación
- \* 電源ユニットの取り付け

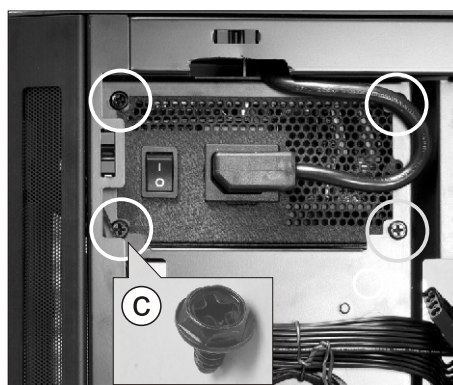

- \* Remove front panel
- \* 拆卸前面板
- \* Retirer le panneau avant
- \* Entfernen Frontplatte
- \* Retire el panel delantero
- \* 前面パネルを取り外す



- \* Remove side glass
- \* 拆卸側面玻璃
- \* Retirer le verre latéral
- \* Entfernen Sie Seitenglas
- \* Retire los cristales laterales
- \* 側面ガラスを削除します

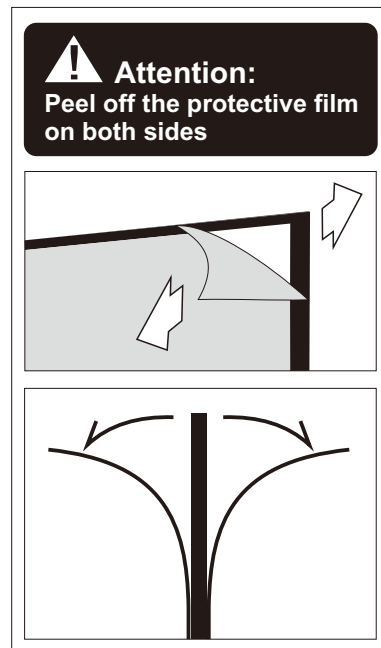

- \* Remove top panel
- \* 拆卸上板
- \* Retirer le panneau supérieur
- \* Entfernen Sie die obere Platte
- \* Retire el panel superior
- \* トップパネルを取り外す

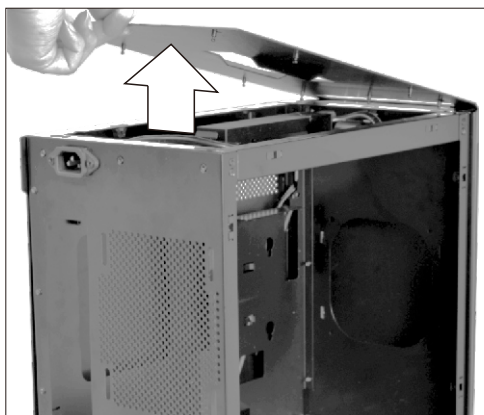

- \* Cable management
- \* 線材管理
- \* Gestion des câbles
- \* Kabelmanagement
- \* Mantenimiento de cable
- \* ケーブル管理

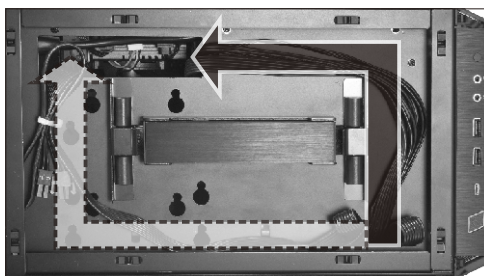

- \* 2.5" SSD / 3.5" HDD installation
- \* 2.5/3.5吋硬碟安裝
- \* Installation d'un DD 2.5"/3.5"
- \* 2.5/3.5-Zoll-Festplatte installieren
- \* Instalación de unidad de disco duro de 2.5"/3.5"
- \* 2.5"/3.5"ハードディスクの取り付け

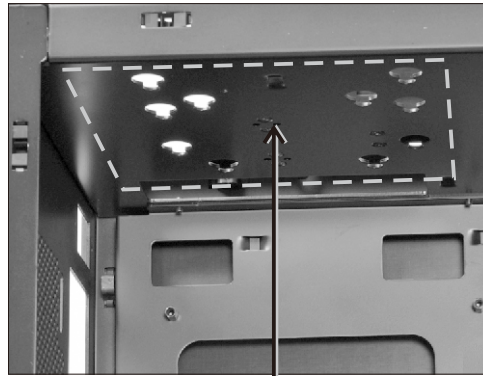

For 2.5"SSD x 1 or 3.5"HDD x 1

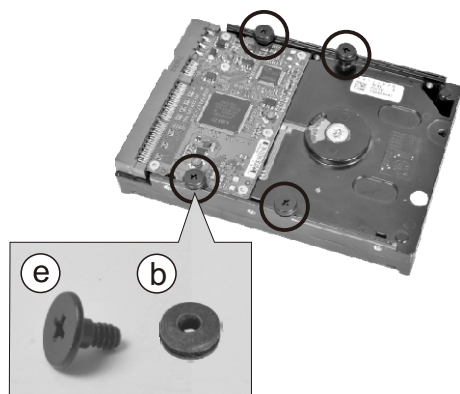
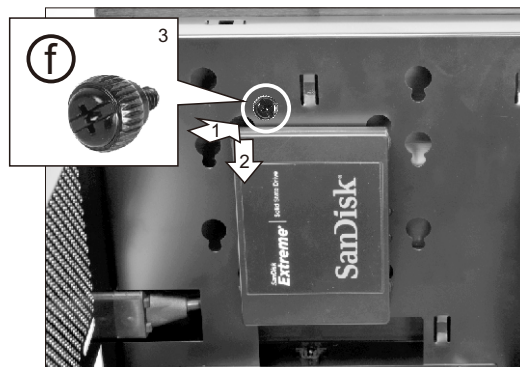
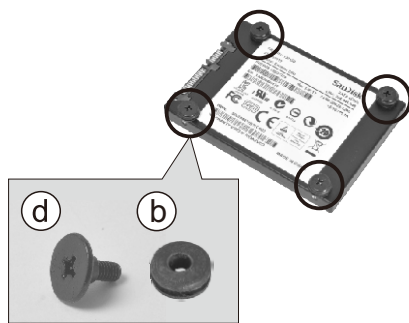

- \* 2.5" SSD installation
- \* 2.5吋硬碟安裝
- \* Installation d'un DD2.5"
- \* 2.5-Zoll-Festplatte installieren
- \* Instalación de unidad de disco duro de 2.5"
- \* 2.5"ハードディスクの取り付け

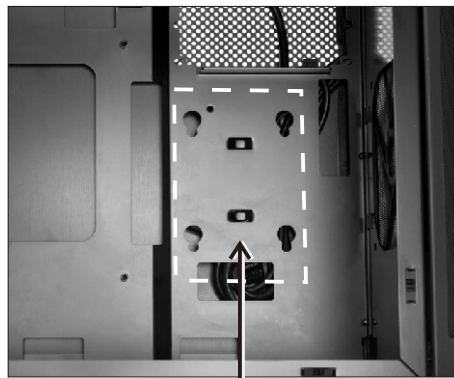

For 2.5"SSD x 1

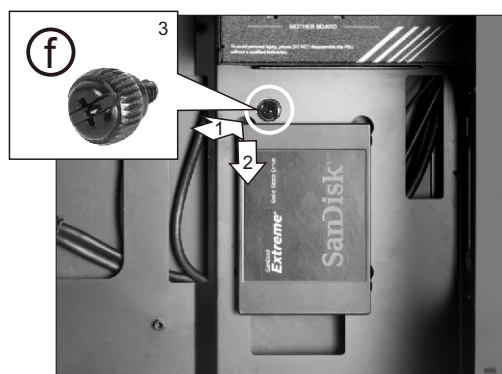
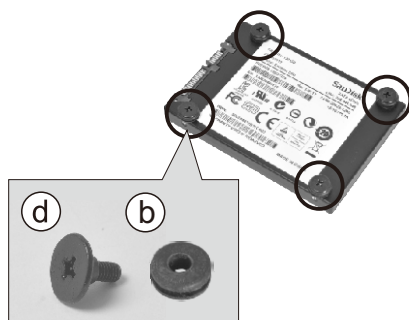



- \* Remove air filters
- \* 空氣濾網拆卸
- \* Retirez les filtres à air
- \* Entfernen Sie Luftfilter
- \* Retire los filtros de aire
- \* エアフィルターの取り外し

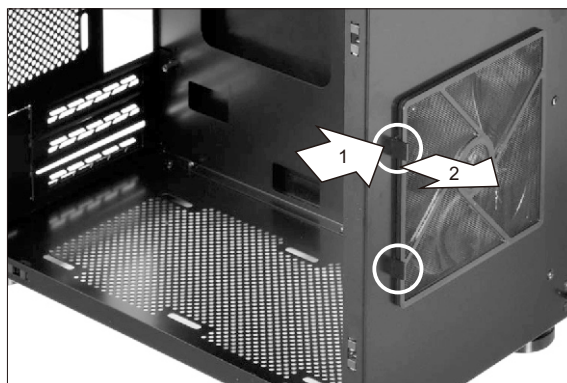

- \* Radiator & cooling support
- \* 散熱器 & 水冷排支援
- \* Assistance radiateur et refroidissement
- \* Kühler- und Kühlungsunterstützung
- \* Radiador y soporte de refrigeración
- \* ラジエーター & 冷却サポート

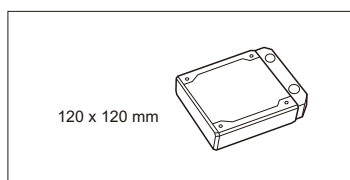



TU150

<http://www.lian-li.com>

G50.TU1500.00